



+2.5 V to +5.5 V, 25 MHz Low Power CMOS Complete DDS

Preliminary Technical Data

AD9833

FEATURES

+2.3 V to +5.5 V Power Supply
25 MHz Speed
Tiny 10-Pin μ SOIC Package
Serial Loading
Sinusoidal/Triangular DAC Output
Power-Down Option
Narrowband SFDR > 72 dB
20 mW Power Consumption at 3 V

APPLICATIONS

Digital Modulation
Portable Equipment
Test Equipment
DDS Tuning

GENERAL DESCRIPTION

This low power DDS device is a numerically controlled oscillator employing a phase accumulator, a SIN ROM and a 10-bit D/A converter integrated on a single CMOS chip. Clock rates up to 25 MHz are supported

with a power supply from +2.3 V to +5.5 V.

Capability for phase modulation and frequency modulation is provided. Frequency accuracy can be controlled to one part in 0.25 billion. Modulation is effected by loading registers through the serial interface.

The AD9833 offers a variety of output waveforms from the VOUT pin. The SIN ROM can be bypassed so that a linear up/down ramp is output from the DAC. If the SIN ROM is not by-passed, a sinusoidal output is available. Also, if a clock output is required, the MSB of the DAC data can be output.

The digital section is internally operated at +2.5 V, irrespective of the value of VDD, by an on board regulator which steps down VDD to +2.5 V, when VDD exceeds +2.5 V.

The AD9833 has a power-down function (SLEEP). This allows sections of the device which are not being used to be powered down, thus minimising the current consumption of the part e.g the DAC can be powered down when a clock output is being generated.

The AD9833 is available in a 10-pin μ SOIC package.

FUNCTIONAL BLOCK DIAGRAM

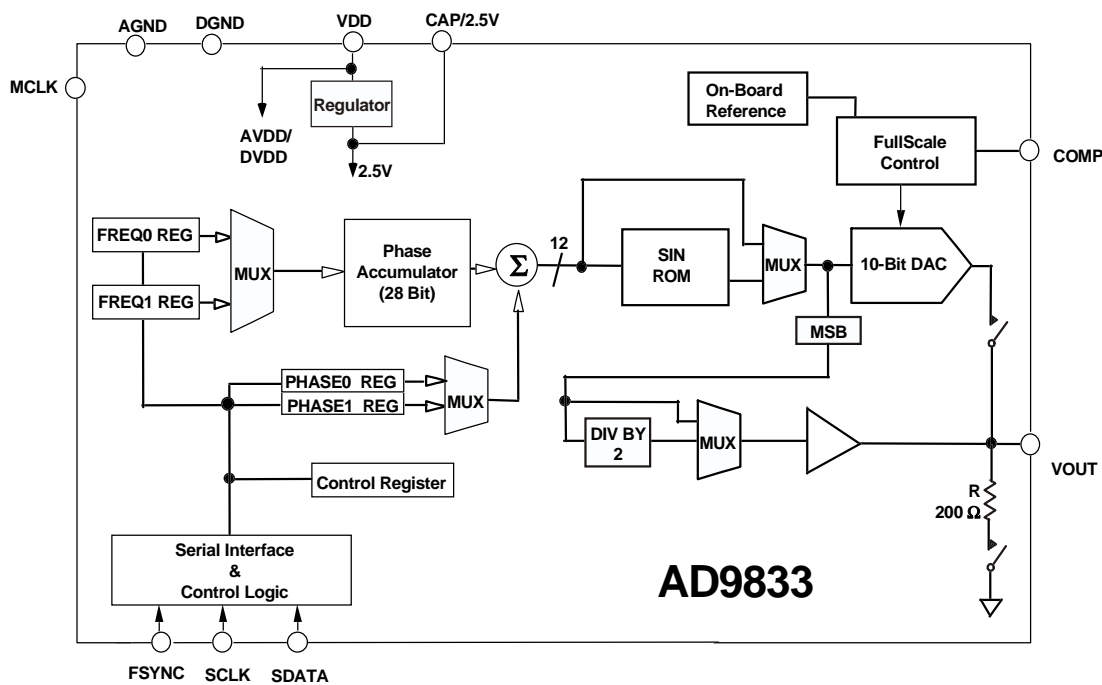

REV PrG 02/02

Information furnished by Analog Devices is believed to be accurate and reliable. However, no responsibility is assumed by Analog Devices for its use, nor for any infringements of patents or other rights of third parties which may result from its use. No license is granted by implication or otherwise under any patent or patent rights of Analog Devices.

One Technology Way, P.O. Box 9106, Norwood, MA 02062-9106, U.S.A.
 Tel: 781/329-4700
 Fax: 781/326-8703
www.analog.com
 © Analog Devices, Inc., 2002

AD9833

SPECIFICATIONS¹

($V_{DD} = +2.3 \text{ V to } +5.5 \text{ V}$; $AGND = DGND = 0 \text{ V}$; $T_A = T_{MIN} \text{ to } T_{MAX}$; $R_{SET} = 6.8 \text{ k}\Omega$ for V_{OUT} unless otherwise noted)

Parameter	Min	Typ	Max	Units	Test Conditions/Comments
SIGNALDAC SPECIFICATIONS					
Resolution		10		Bits	
Update Rate (f_{MAX})			25	MSPS	
Output Compliance ²			0.8	V	
DC Accuracy:					
Integral Nonlinearity		± 1		LSB	
Differential Nonlinearity		± 0.5		LSB	
DDSSPECIFICATIONS					
Dynamic Specifications:					
Signal to Noise Ratio	50			dB	$f_{MCLK} = 25 \text{ MHz}$, $f_{OUT} = 1.5 \text{ kHz}$
Total Harmonic Distortion			-53	dBc	$f_{MCLK} = 25 \text{ MHz}$, $f_{OUT} = 1.5 \text{ kHz}$
Spurious Free Dynamic Range (SFDR):					
Wideband ($\pm 2 \text{ MHz}$)	50			dBc	$f_{MCLK} = 25 \text{ MHz}$, $f_{OUT} = f_{MCLK}/3$
	55			dBc	$f_{MCLK} = 25 \text{ MHz}$, $f_{OUT} = 0.5 \text{ MHz}$
NarrowBand ($\pm 50 \text{ kHz}$)	72			dBc	$f_{MCLK} = 25 \text{ MHz}$, $f_{OUT} = f_{MCLK}/3$
	75			dBc	$f_{MCLK} = 25 \text{ MHz}$, $f_{OUT} = 0.5 \text{ MHz}$
Clock Feedthrough		-55		dBc	
Wake Up Time		1		ms	
OUTPUT BUFFER					
Output Rise/Fall Time		20		ns	Using a 15 pF Load
Output Jitter		100		ps rms	When DAC data MSB is output
VOLTAGE REFERENCE					
Internal Reference	1.116	1.2	1.284	V	$1.2 \text{ V} \pm 7\%$
LOGIC INPUTS					
V_{INH} , Input High Voltage	$V_{DD} - 0.9$ $V_{DD} - 0.5$ 2			V V V	+3.6 V to +5.5 V Power Supply +2.7 V to +3.6 V Power Supply +2.3 V to +2.7 V Power Supply
V_{INL} , Input Low Voltage			0.9 0.5	V V	+3.6 V to +5.5 V Power Supply +2.3 V to +3.6 V Power Supply
I_{INH} , Input Current			1	μA	
C_{IN} , Input Capacitance			10	pF	
POWER SUPPLIES					
VDD	2.3		5.5	V	$f_{MCLK} = 25 \text{ MHz}$, $f_{OUT} = f_{MCLK}/7$
I_{AA}^3			5	mA	
I_{DD}^3		$1 + 0.04/\text{MHz}$		mA	
$I_{AA} + I_{DD}^3$		7	10	mA	3 V Power Supply
		10	15	mA	5 V Power Supply
Low Power Sleep Mode ³		0.25		mA	DAC and Internal Clock Powered Down

NOTES

¹Operating temperature range is as follows: B Version: -40°C to $+85^\circ\text{C}$; typical specifications are at 25°C

²Guaranteed by Design.

³Measured with the digital inputs static and equal to 0 V or DVDD.

Specifications subject to change without notice. There is 95% test coverage of the digital circuitry.

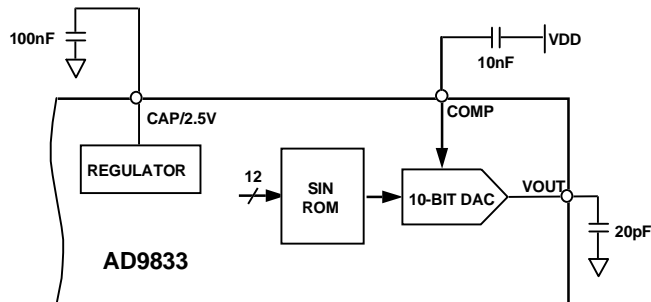

Figure 1. Test Circuit With which Specifications are tested.

TIMING CHARACTERISTICS¹ ($V_{DD} = +2.3\text{ V to }+5.5\text{ V}$; $AGND = DGND = 0\text{ V}$, unless otherwise noted)

Parameter	Limit at T_{MIN} to T_{MAX}	Units	Test Conditions/Comments
t_1	40	ns min	MCLK Period
t_2	16	ns min	MCLK High Duration
t_3	16	ns min	MCLK Low Duration
t_4	25	ns min	SCLK Period
t_5	10	ns min	SCLK High Duration
t_6	10	ns min	SCLK Low Duration
t_7	5	ns min	FSYNC to SCLK Falling Edge Setup Time
t_8	10	ns min	FSYNC to SCLK Hold Time
t_9	$t_4 - 5$	ns max	Data Setup Time
t_{10}	3	ns min	Data Hold Time

¹ Guaranteed by design, not production tested.

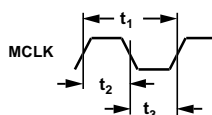

Figure 2. Master Clock

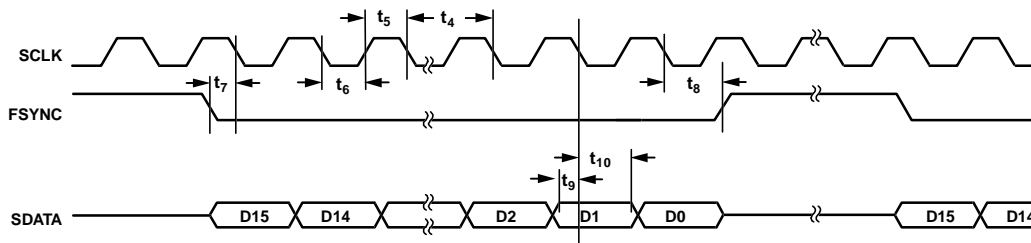

Figure 3. Serial Timing

CAUTION

ESD (electrostatic discharge) sensitive device. Electrostatic charges as high as 4000 V readily accumulate on the human body and test equipment and can discharge without detection. Although the AD9833 features proprietary ESD protection circuitry, permanent damage may occur on devices subjected to high energy electrostatic discharges. Therefore, proper ESD precautions are recommended to avoid performance degradation or loss of functionality.



PRELIMINARY TECHNICAL DATA

AD9833

ABSOLUTE MAXIMUM RATINGS*

(T_A = +25°C unless otherwise noted)

VDD to AGND-0.3 V to +6 V
VDD to DGND-0.3 V to +6 V
AGND to DGND-0.3 V to +0.3 V
CAP/2.5V 2.75 V
Digital I/O Voltage to DGND	..-0.3 V to VDD + 0.3 V
Analog I/O Voltage to AGND	..-0.3 V to VDD + 0.3 V
Operating Temperature Range	
Industrial (B Version)-40°C to +85°C
Storage Temperature Range-65°C to +150°C

Maximum Junction Temperature 150°C
μSOIC Package	
θ _{JA} Thermal Impedance206°C/W
θ _{JC} Thermal Impedance44°C/W
Lead Temperature, Soldering (10 sec) 300°C
IR Reflow, Peak Temperature 220°C

*Stresses above those listed under “Absolute Maximum Ratings” may cause permanent damage to the device. This is a stress rating only and functional operation of the device at these or any other conditions above those listed in the operational sections of this specification is not implied. Exposure to absolute maximum rating conditions for extended periods may affect device reliability.

ORDERING GUIDE

Model	Temperature Range	Package Description	Package Option
AD9833BRM EVAL-AD9833EB	-40°C to +85°C	14-Pin μSOIC (Micro Small Outline IC) Evaluation Board	RM-10

PIN CONFIGURATION

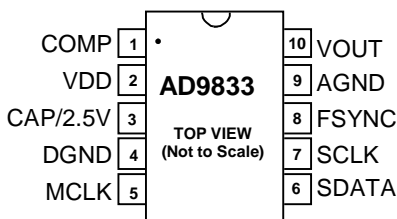

PIN DESCRIPTION

Pin #	Mnemonic	Function
POWER SUPPLY		
2	VDD	Positive power supply for the analog section and the digital interface sections. The on board 2.5 V regulator is also supplied from VDD. VDD can have a value from +2.3 V to +5.5 V. A 0.1 μF and 10 μF decoupling capacitor should be connected between VDD and AGND.
3	CAP/2.5V	The digital circuitry operates from a +2.5 V power supply. This +2.5 V is generated from VDD using an on board regulator (when VDD exceeds +2.7 V). The regulator requires a decoupling capacitor of typically 100 nF, which is connected from CAP/2.5V to DGND. If VDD is equal to or less than +2.7 V, CAP/2.5V should be tied directly to VDD.
4	DGND	Digital Ground.
9	AGND	Analog Ground.
ANALOG SIGNAL AND REFERENCE		
1	COMP	A DAC Bias Pin. This pin is used for de-coupling the DAC bias voltage.
10	VOUT	Voltage Output. The analog and digital output from the AD9833 is available at this pin. An external load resistor is not required as the device has a 200Ω resistor on board.
DIGITAL INTERFACE AND CONTROL		
5	MCLK	Digital Clock Input. DDS output frequencies are expressed as a binary fraction of the frequency of MCLK. The output frequency accuracy and phase noise are determined by this clock.
6	SDATA	Serial Data Input. The 16-bit serial data word is applied to this input.
7	SCLK	Serial Clock Input. Data is clocked into the AD9833 on each falling SCLK edge.
8	FSYNC	Active Low Control Input. This is the frame synchronisation signal for the input data. When FSYNC is taken low, the internal logic is informed that a new word is being loaded into the device.

Typical Performance Characteristics

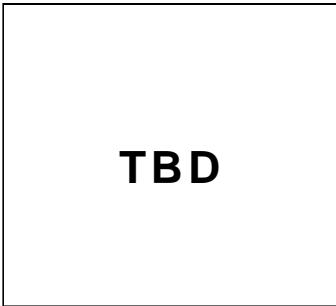

TPC 1. Typical Current Consumption vs. MCLK Frequency

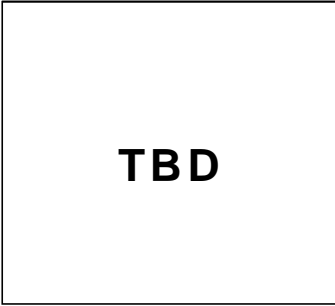

TPC 2. Narrow Band SFDR vs. MCLK Frequency

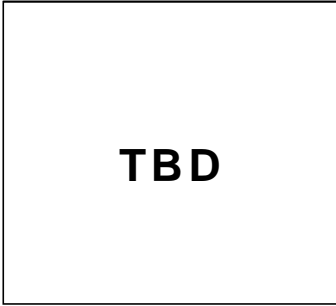

TPC 3. Wide Band SFDR vs. MCLK Frequency

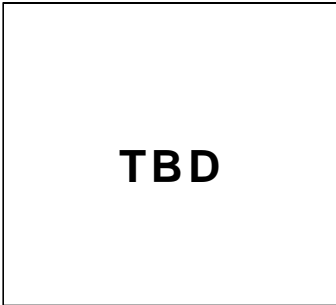

TPC 4. Wide Band SFDR vs. f_{OUT}/f_{MCLK} for Various MCLK Frequencies

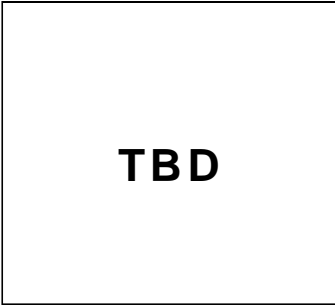

TPC 5. SNR vs. MCLK Frequency

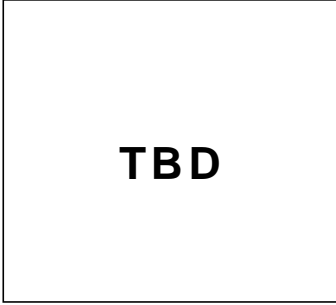

TPC 6. SNR vs. f_{OUT}/f_{MCLK} for Various MCLK Frequencies

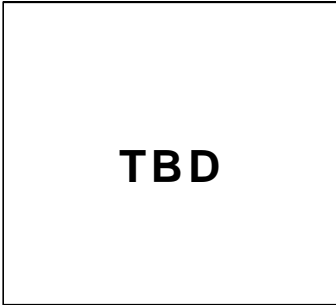

TPC 7. Wake-Up Time vs. Temperature

AD9833

Typical Performance Characteristics

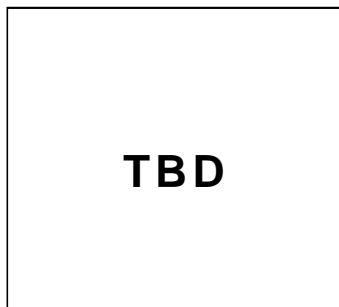

TPC 9. $f_{MCLK} = 10 \text{ MHz}$; $f_{OUT} = 2.4 \text{ kHz}$;
Frequency Word = 000FBA9

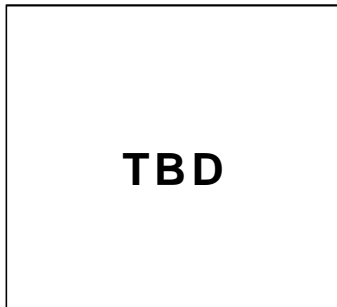

TPC 10. $f_{MCLK} = 10 \text{ MHz}$; $f_{OUT} = 1.43 \text{ kHz}$;
 $= f_{MCLK}/7$;
Frequency Word = 2492492

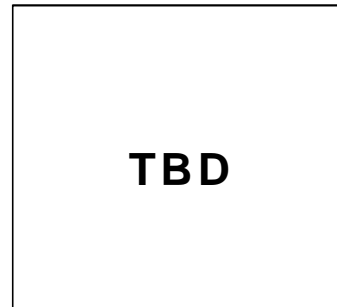

TPC 11. $f_{MCLK} = 10 \text{ MHz}$; $f_{OUT} = 3.33 \text{ kHz}$;
 $= f_{MCLK}/3$;
Frequency Word = 5555555

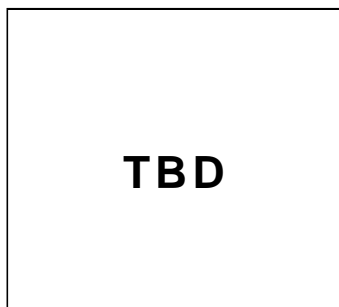

TPC 12. $f_{MCLK} = 25 \text{ MHz}$; $f_{OUT} = 6 \text{ kHz}$;
Frequency Word = 000FBA9

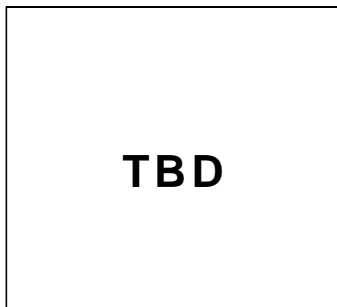

TPC 13. $f_{MCLK} = 25 \text{ MHz}$; $f_{OUT} = 60 \text{ kHz}$;
Frequency Word = 009D495

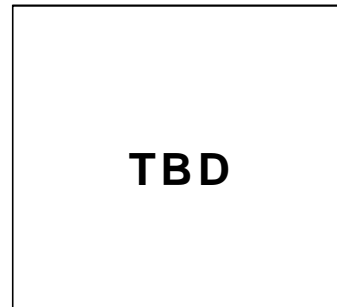

TPC 14. $f_{MCLK} = 25 \text{ MHz}$; $f_{OUT} = 600 \text{ kHz}$;
Frequency Word = 0624DD3

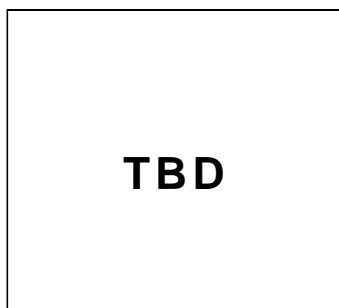

TPC 15. $f_{MCLK} = 25 \text{ MHz}$;
 $f_{OUT} = 2.4 \text{ MHz}$;
Frequency Word = 189374D

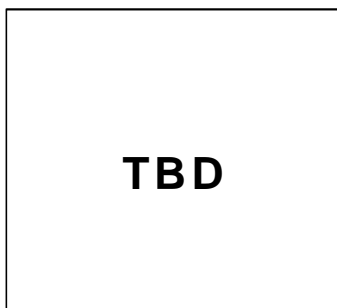

TPC 16. $f_{MCLK} = 25 \text{ MHz}$;
 $f_{OUT} = 3.857 \text{ MHz} = f_{MCLK}/7$;
Frequency Word = 277EE4F

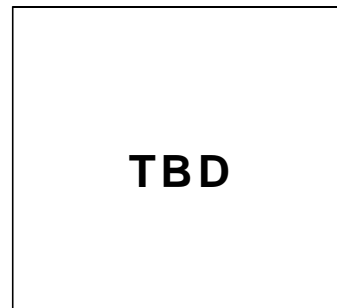

TPC 17. $f_{MCLK} = 25 \text{ MHz}$;
 $f_{OUT} = 8.333 \text{ MHz} = f_{MCLK}/3$;
Frequency Word = 555475C

TERMINOLOGY**Integral Nonlinearity**

This is the maximum deviation of any code from a straight line passing through the endpoints of the transfer function. The endpoints of the transfer function are zero scale, a point 0.5 LSB below the first code transition (000...00 to 000...01) and full scale, a point 0.5 LSB above the last code transition (111...10 to 111...11). The error is expressed in LSBs.

Differential Nonlinearity

This is the difference between the measured and ideal 1 LSB change between two adjacent codes in the DAC. A specified differential nonlinearity of ± 1 LSB maximum ensures monotonicity.

Output Compliance

The output compliance refers to the maximum voltage that can be generated at the output of the DAC to meet the specifications. When voltages greater than that specified for the output compliance are generated, the AD9833 may not meet the specifications listed in the data sheet.

Spurious Free Dynamic Range

Along with the frequency of interest, harmonics of the fundamental frequency and images of these frequencies are present at the output of a DDS device. The spurious free dynamic range (SFDR) refers to the largest spur or harmonic which is present in the band of interest. The wide band SFDR gives the magnitude of the largest harmonic or spur relative to the magnitude of the fundamental frequency in the 0 to Nyquist bandwidth. The narrow band SFDR gives the attenuation of the largest spur or harmonic in a bandwidth of ± 200 kHz about the fundamental frequency.

Total Harmonic Distortion

Total Harmonic Distortion (THD) is the ratio of the rms sum of harmonics to the rms value of the fundamental. For the AD9834, THD is defined as:

$$\text{THD} = 20 \log \sqrt{V_2^2 + V_3^2 + V_4^2 + V_5^2 + V_6^2} / V_1$$

where V_1 is the rms amplitude of the fundamental and V_2, V_3, V_4, V_5 and V_6 are the rms amplitudes of the second through sixth harmonic.

Signal-to-Noise Ratio (SNR)

S/N is the ratio of the rms value of the measured output signal to the rms sum of all other spectral components below the Nyquist frequency, excluding the first six harmonics and dc. The value for SNR is expressed in decibels.

Clock Feedthrough

There will be feedthrough from the MCLK input to the analog output. Clock feedthrough refers to the magnitude of the MCLK signal relative to the fundamental frequency in the AD9834's output spectrum.

THEORY OF OPERATION

Sine waves are typically thought of in terms of their magnitude form $a(t) = \sin(\omega t)$. However, these are nonlinear and not easy to generate except through piecewise construction. On the other hand, the angular information is linear in nature. That is, the phase angle rotates through a fixed angle for each unit of time. The angular rate depends on the frequency of the signal by the traditional rate of $\omega = 2\pi f$.

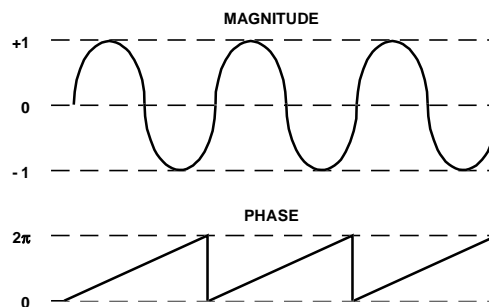

Figure 4. Sine Wave

Knowing that the phase of a sine wave is linear and given a reference interval (clock period), the phase rotation for that period can be determined.

$$\Delta \text{Phase} = \omega \delta t$$

Solving for ω

$$\omega = \Delta \text{Phase} / \delta t = 2\pi f$$

Solving for f and substituting the reference clock frequency for the reference period ($1/f_{\text{MCLK}} = \delta t$)

$$f = \Delta \text{Phase} \times f_{\text{MCLK}} / 2\pi$$

The AD9833 builds the output based on this simple equation. A simple DDS chip can implement this equation with three major subcircuits:

Numerical Controlled Oscillator + Phase Modulator
SIN ROM
Digital- to- Analog Converter.

Each of these sub-circuits are discussed in the following section.

AD9833

CIRCUIT DESCRIPTION

The AD9833 is a fully integrated Direct Digital Synthesis (DDS) chip. The chip requires one reference clock, one low precision resistor and decoupling capacitors to provide digitally created sine waves up to 12.5 MHz. In addition to the generation of this RF signal, the chip is fully capable of a broad range of simple and complex modulation schemes. These modulation schemes are fully implemented in the digital domain allowing accurate and simple realization of complex modulation algorithms using DSP techniques.

The internal circuitry of the AD9833 consists of the following main sections: a Numerical Controlled Oscillator (NCO), Frequency and Phase Modulators, SIN ROM, a Digital-to-Analog Converter, and a Regulator.

Numerical Controlled Oscillator + Phase Modulator

This consists of two frequency select registers, a phase accumulator, two phase offset registers and a phase offset adder. The main component of the NCO is a 28-bit phase accumulator which assembles the phase component of the output signal. Continuous time signals have a phase range of 0 to 2π . Outside this range of numbers, the sinusoid functions repeat themselves in a periodic manner. The digital implementation is no different. The accumulator simply scales the range of phase numbers into a multibit digital word. The phase accumulator in the AD9833 is implemented with 28 bits. Therefore, in the AD9833, $2\pi = 2^{28}$. Likewise, the $\Delta Phase$ term is scaled into this range of numbers $0 < \Delta Phase < 2^{28} - 1$. Making these substitutions into the equation above

$$f = \Delta Phase \times f_{MCLK} / 2^{28}$$

where $0 < \Delta Phase < 2^{28} - 1$.

The input to the phase accumulator (i.e., the phase step) can be selected either from the `FREQ0` Register or `FREQ1` Register and this is controlled by the `FSELECT` bit. NCOs inherently generate continuous phase signals, thus avoiding any output discontinuity when switching between frequencies.

Following the NCO, a phase offset can be added to perform phase modulation using the 12-bit Phase Registers. The contents of one of these phase registers is added to the most significant bits of the NCO. The AD9833 has two Phase registers, the resolution of these registers being $2\pi/4096$.

SIN ROM

To make the output from the NCO useful, it must be converted from phase information into a sinusoidal value. Since phase information maps directly into amplitude, the SIN ROM uses the digital phase information as an address to a look-up table, and converts the phase information into amplitude. Although the NCO contains a 28-bit phase accumulator, the output of the NCO is truncated to 12 bits. Using the full resolution of the phase accumulator is impractical and unnecessary as this would require a look-up table of 2^{28} entries. It is necessary only to have sufficient phase resolution such that the errors due to truncation are smaller than the resolution of the 10-bit DAC. This requires the SIN ROM to have two bits of

phase resolution more than the 10-bit DAC.

The SIN ROM is enabled using the `MODE` bit (`D1`) in the control register. This is explained further in Table 11.

Digital-to-Analog Converter

The AD9833 includes a high impedance current source 10-bit DAC. The DAC receives the digital words from the SIN ROM and converts them into the corresponding analog voltages.

The DAC is configured for single-ended operation. An external load resistor is not required as the device has a 200 Ω resistor on board. The DAC generates an output voltage of typically 0.6 Vpp.

Regulator

VDD provides the power supply required for the analog section and the digital section of the AD9833. This supply can have a value of +2.3V to +5.5V

The internal digital section of the AD9833 is operated at 2.5 V. An on-board regulator steps down the voltage applied at VDD to 2.5 V. When the applied voltage at the VDD pin of the AD9833 is equal to or less than 2.7 V, the pins `CAP/2.5V` and VDD should be tied together, thus by-passing the on-board regulator.

FUNCTIONAL DESCRIPTION

Serial Interface

The AD9833 has a standard 3-wire serial interface, which is compatible with SPI, QSPI, MICROWIRE and DSP interface standards.

Data is loaded into the device as a 16-bit word under the control of a serial clock input, SCLK. The timing diagram for this operation is given in Figure 3.

The FSYNC input is a level triggered input that acts as a frame synchronisation and chip enable. Data can only be transferred into the device when FSYNC is low. To start the serial data transfer, FSYNC should be taken low, observing the minimum FSYNC to SCLK falling edge setup time, t_7 . After FSYNC goes low, serial data will be shifted into the device's input shift register on the falling edges of SCLK for 16 clock pulses. FSYNC may be taken high after the sixteenth falling edge of SCLK, observing the minimum SCLK falling edge to FSYNC rising edge time, t_8 . Alternatively, FSYNC can be kept low for a multiple of 16 SCLK pulses, and then brought high at the end of the data transfer. In this way, a continuous stream of 16 bit words can be loaded while FSYNC is held low, FSYNC only going high after the 16th SCLK falling edge of the last word loaded.

The SCLK can be continuous or, alternatively, the SCLK can idle high or low between write operations.

Powering up the AD9833

The flow chart in Figure 6 shows the operating routine for the AD9833. When the AD9833 is powered up, the part should be reset. This will reset appropriate internal registers to zero to provide an analog output of midscale. To avoid spurious DAC outputs while the AD9833 is being initialized, the RESET bit should be set to 1 until the part is ready to begin generating an output. RESET does not

reset the phase, frequency or control registers. These registers will contain invalid data and, therefore, should be set to a known value by the user. The RESET bit should then be set to 0 to begin generating an output. A signal will appear at the DAC output 7 MCLK cycles after RESET is set to 0.

Latency

Associated with each asynchronous write operation in the AD9833 is a latency. If a selected frequency/phase register is loaded with a new word there is a delay of 7 to 8 MCLK cycles before the analog output will change. (There is an uncertainty of one MCLK cycle as it depends on the position of the MCLK rising edge when the data is loaded into the destination register.)

The Control Register

The AD9833 contains a 16-bit control register which sets up the AD9833 as the user wishes to operate it. All control bits, except MODE, are sampled on the internal negative edge of MCLK.

Table 2, on the following page, describes the individual bits of the control register. The different functions and the various output options from the AD9833 are described in more detail in the section following Table 2.

To inform the AD9833 that you wish to alter the contents of the Control register, D15 and D14 must be set to '0' as shown below.

Table 1. Control Register

D15	D14	D13	D0
0	0	CONTROL BITS	

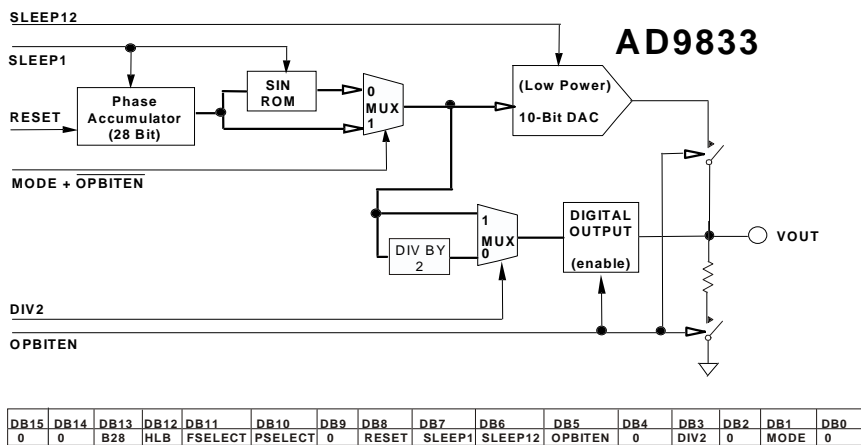

Figure 5. Function of Control Bits

Table 2. Description of bits in the Control Register

Bit	Name	Function
D13	B28	Two write operations are required to load a complete word into either of the Frequency registers. B28 = '1' allows a complete word to be loaded into a frequency register in two consecutive writes. The first write contains the 14 LSBs of the frequency word and the next write will contain the 14 MSBs. The first two bits of each sixteen-bit word define the frequency register to which the word is loaded, and should therefore be the same for both of the consecutive writes. Refer to table 6 for the appropriate addresses. The write to the frequency register occurs after both words have been loaded, so the register never holds an intermediate value. An example of a complete 28-bit write is shown in table 5. When B28 = '0' the 28-bit frequency register operates as 2 14-bit registers, one containing the 14 MSBs and the other containing the 14 LSBs. This means that the 14 MSBs of the frequency word can be altered independent of the 14 LSBs and vice versa. To alter the 14 MSBs or the 14 LSBs, a single write is made to the appropriate Frequency address. The control bit D12 (HLB) informs the AD9833 whether the bits to be altered are the 14 MSBs or 14 LSBs.
D12	HLB	This control bit allows the user to continuously load the MSBs or LSBs of a frequency register while ignoring the remaining 14 bits. This is useful if the complete 28 bit resolution is not required. HLB is used in conjunction with D13 (B28). This control bit indicates whether the 14 bits being loaded are being transferred to the 14 MSBs or 14 LSBs of the addressed frequency register. D13 (B28) must be set to '0' to be able to change the MSBs and LSBs of a frequency word separately. When D13 (B28) = '1', this control bit is ignored. HLB = '1' allows a write to the 14 MSBs of the addressed frequency register. HLB = '0' allows a write to the 14 LSBs of the addressed frequency register.
D11	FSELECT	The FSELECT bit defines whether the FREQ0 register or the FREQ1 register is used in the phase accumulator.
D10	PSELECT	The PSELECT bit defines whether the PHASE0 register or the PHASE1 register data is added to the output of the phase accumulator.
D9	Reserved	This bit should be set to 0.
D8	RESET	RESET = '1' resets internal registers to zero, which corresponds to an analog output of midscale. RESET = '0' disables Reset. This function is explained further in Table 9.
D7	SLEEP1	When SLEEP1 = '1', the internal MCLK clock is disabled. The DAC output will remain at its present value as the NCO is no longer accumulating. When SLEEP1 = '0' MCLK is enabled. This function is explained further in Table 10.
D6	SLEEP12	SLEEP12 = '1' powers down the on-chip DAC. This is useful when the AD9833 is used to output the MSB of the DAC data. SLEEP12 = '0' implies that the DAC is active. This function is explained further in Table 10.
D5	OPBITEN	The function of this bit, in association with D1 (MODE), is to control what is output at the VOUT pin. This is explained further in Table 11. When OPBITEN = '1' the output of the DAC is no longer available at the VOUT pin. Instead, the MSB (or MSB/2) of the DAC data is connected to the VOUT pin. This is useful as a coarse clock source. The bit DIV2 controls whether it is the MSB or MSB/2 that is output. When OPBITEN equals 0, the DAC is connected to VOUT. The MODE bit determines whether it is a sinusoidal or a ramp output that is available.
D4	Reserved	This bit must be set to 0.
D3	DIV2	DIV2 is used in association with D5 (OPBITEN). This is explained further in Table 11. When DIV2 = '1', the MSB of the DAC data is passed directly to the VOUT pin. When DIV2 = '0', the MSB/2 of the DAC data is output at the VOUT pin.
D2	Reserved	This bit must always be set to 0.
D1	MODE	This bit is used in association with OPBITEN (D5). The function of this bit is to control what is output at the VOUT pin when the on-chip DAC is connected to VOUT. This bit should be set to '0' if the control bit OPBITEN = '1'. This is explained further in Table 11. When MODE = '1', the SIN ROM is bypassed, resulting in a ramp output from the DAC. When MODE = '0' the SIN ROM is used to convert the phase information into amplitude information which results in a sinusoidal signal at the output.
D0	Reserved	This bit must always be set to 0.

The Frequency and Phase Registers

The AD9833 contains 2 frequency registers and 2 phase registers. These are described in Table 3 below.

Table 3. Frequency/Phase Registers

Register	Size	Description
FREQ0	28 Bits	Frequency Register 0. When the FSELECT bit = 0, this register defines the output frequency as a fraction of the MCLK frequency.
FREQ1	28 Bits	Frequency Register 1. When the FSELECT bit = 1, this register defines the output frequency as a fraction of the MCLK frequency.
PHASE0	12 Bits	Phase Offset Register 0. When the PSELECT bit = 0, the contents of this register are added to the output of the phase accumulator.
PHASE1	12 Bits	Phase Offset Register 1. When the PSELECT bit = 1, the contents of this register are added to the output of the phase accumulator.

The analog output from the AD9833 is

$$f_{MCLK}/2^{28} \times \text{FREQREG}$$

where FREQREG is the value loaded into the selected frequency register. This signal will be phase shifted by

$$2\pi/4096 \times \text{PHASEREG}$$

where PHASEREG is the value contained in the selected phase register.

The flow chart in Figure 8 shows the routine for writing to the frequency and phase registers of the AD9833.

Writing to a Frequency Register:

When writing to a frequency register, bits D15 and D14 give the address of the frequency register.

Table 4. Frequency Register Bits

D15	D14	D13	D0
0	1	MSB	14 FREQ0 REG BITS
1	0	MSB	14 FREQ1 REG BITS

If the user wishes to alter the entire contents of a frequency register, two consecutive writes to the same address must be performed, as the frequency registers are 28 bits wide. The first write will contain the 14 LSBs while the second write will contain the 14 MSBs. For this mode of operation, the control bit B28 (D13) should be set to 1. An example of a 28-bit write is shown in Table 5.

Table 5: Writing 3FFF0000 to FREQ0 REG

SDATA input	Result of input word
0010 0000 0000 0000	Control word write (D15, D14 = 00); B28 (D13) = 1; HLB (D12) = X
0100 0000 0000 0000	FREQ0 REG write (D15, D14 = 01); 14 LSBs = 0000
0111 1111 1111 1111	FREQ0 REG write (D15, D14 = 01); 14 MSBs = 3FFF

In some applications, the user does not need to alter all 28 bits of the frequency register. With coarse tuning, only the 14 MSBs are altered while with fine tuning, only the 14 LSBs are altered. By setting the control bit B28 (D13) to 0, the 28-bit frequency register operates as 2 14-bit registers, one containing the 14 MSBs and the other containing the 14 LSBs. This means that the 14 MSBs of the frequency word can be altered independent of the 14 LSBs and vice versa. Bit HLB (D12) in the control register identifies which 14 bits are being altered. Examples of this are shown below.

Table 6: Writing 3FFF to the 14 LSBs of FREQ1 REG

SDATA input	Result of input word
0000 0000 0000 0000	Control word write (D15, D14 = 00); B28 (D13) = 0; HLB (D12) = 0, i.e. LSBs
1011 1111 1111 1111	FREQ1 REG write (D15, D14 = 10); 14 LSBs = 3FFF

Table 7: Writing 3FFF to the 14 MSBs of FREQ0 REG

SDATA input	Result of Input word
0001 0000 0000 0000	Control word write (D15, D14 = 00); B28 (D13) = 0; HLB (D12) = 1, i.e. MSBs
0111 1111 1111 1111	FREQ0 REG write (D15, D14 = 01); 14 MSBs = 3FFF

Writing to a Phase Register:

When writing to a phase register, bits D15 and D14 are set to 11. Bit D13 identifies which phase register is being loaded.

Table 8. Phase Register Bits

D15	D14	D13	D12	D11	D0
1	1	0	X	MSB	12 PHASE0 BITS
1	1	1	X	MSB	12 PHASE1 BITS

The RESET Function

The RESET function resets appropriate internal registers to zero to provide an analog output of midscale. RESET does not reset the phase, frequency or control registers. When the AD9833 is powered up, the part should be reset. To reset the AD9833, set the RESET bit to 1. To take the part out of reset, set the bit to 0. A signal will

AD9833

appear at the DAC output 7 MCLK cycles after RESET is set to 0.

Table 9: Applying RESET

RESET bit	Result
0	No Reset Applied
1	Internal Registers Reset

The Sleep Function

Sections of the AD9833 which are not in use can be powered down to minimise power consumption. This is done using the Sleep Function. The parts of the chip that can be powered down are the Internal clock and the DAC. The bits required for the Sleep Function are outlined in Table 10.

Table 10: Applying the SLEEP Function

SLEEP1 bit	SLEEP12 bit	Result
0	0	No powerdown
0	1	DAC Powered Down
1	0	Internal Clock disabled
1	1	Both the DAC powered down and the Internal Clock disabled

DAC Powered Down: This is useful when the AD9833 is used to output the MSB of the DAC data only. In this case, the DAC is not required so it can be powered down to reduce power consumption.

Internal Clock disabled: When the internal clock of the AD9833 is disabled the DAC output will remain at its present value as the NCO is no longer accumulating. New frequency, phase and control words can be written to the part when the SLEEP1 control bit is active. The synchronising clock is still active which means that the selected frequency and phase registers can also be changed using the control bits. Setting the SLEEP1 bit equal to 0 enables the MCLK. Any changes made to the registers while SLEEP1 was active will be seen at the output after a certain latency.

The VOUT Pin

The AD9833 offers a variety of outputs from the chip, all of which are available from the VOUT pin. The choice of outputs are:

- The MSB of the DAC data,
- A sinusoidal output or
- A ramp output.

The bits OPBITEN (D5) and MODE (D1) in the control register are used to decide which output is available from the AD9833. This is explained further below and also in Table 11.

MSB of the DAC data: The MSB of the DAC data can be output from the AD9833. By setting the OPBITEN (D5) control bit to 1, the MSB of the DAC data is available at the VOUT pin. This is useful as a coarse clock source.

This square wave can also be divided by 2 before being output. The bit DIV2 (D3) in the control register controls the frequency of this output from the VOUT pin.

Sinusoidal Output: The SIN ROM is used to convert the phase information from the frequency and phase registers into amplitude information which results in a sinusoidal signal at the output. To have a sinusoidal output from the VOUT pin, set the bit MODE (D1) = 0 and the OPBITEN (D5) bit to 0.

Up/Down Ramp Output: The SIN ROM can be bypassed so that the truncated digital output from the NCO is sent to the DAC. In this case, the output is no longer sinusoidal. The DAC will produce a ramp up/down function. To have a ramp output from the VOUT pin set the bit MODE (D1) = 1.

Note that the SLEEP12 bit must be 0 (i.e. the DAC is enabled) when using this pin.

Table 11: Various Outputs from VOUT

OPBITEN bit	MODE bit	DIV2 bit	VOUT Pin
0	0	X	Sinusoid
0	1	X	Up/Down Ramp
1	0	0	DAC data MSB / 2
1	0	1	DAC data MSB
1	1	X	Reserved

APPLICATIONS

Because of the various output options available from the part, the AD9833 can be configured to suit a wide variety of applications.

One of the areas where the AD9833 is suitable is in modulation applications. The part can be used to perform simple modulation such as FSK. More complex modulation schemes such as GMSK and QPSK can also be implemented using the AD9833.

In an FSK application, the two frequency registers of the AD9833 are loaded with different values; one frequency will represent the space frequency while the other will represent the mark frequency. Using the FSELECT bit in the control register of the AD9833, the user can modulate the carrier frequency between the two values.

The AD9833 has two phase registers; this enables the part to perform PSK. With phase shift keying, the carrier frequency is phase shifted, the phase being altered by an amount which is related to the bit stream being input to the modulator.

The AD9833 is also suitable for signal generator applications. Because the MSB of the DAC data is available at the VOUT pin, the device can be used to generate a square wave.

With its low current consumption, the part is suitable for applications in which it can be used as a local oscillator.

GROUNDING AND LAYOUT

The printed circuit board that houses the AD9833 should be designed so that the analog and digital sections are separated and confined to certain areas of the board. This facilitates the use of ground planes which can be separated easily. A minimum etch technique is generally best for ground planes as it gives the best shielding. Digital and analog ground planes should only be joined in one place. If the AD9833 is the only device requiring an AGND to DGND connection, then the ground planes should be connected at the AGND and DGND pins of the AD9833. If the AD9833 is in a system where multiple devices require AGND to DGND connections, the connection should be made at one point only, a star ground point that should be established as close as possible to the AD9833.

Avoid running digital lines under the device as these will couple noise onto the die. The analog ground plane should be allowed to run under the AD9833 to avoid noise coupling. The power supply lines to the AD9833 should use as large a track as is possible to provide low impedance paths and reduce the effects of glitches on the power supply line. Fast switching signals such as clocks should be shielded with digital ground to avoid radiating noise to other sections of the board. Avoid crossover of digital and analog signals. Traces on opposite sides of the board should run at right angles to each other. This will reduce the effects of feedthrough through the board. A microstrip technique is by far the best but is not always possible with a double-sided board. In this technique, the component side of the board is dedicated to ground planes while signals are placed on the other side.

Good decoupling is important. The AD9833 should have supply bypassing of 0.1 μ F ceramic capacitors in parallel with 10 μ F tantalum capacitors. To achieve the best from the decoupling capacitors, they should be placed as close as possible to the device, ideally right up against the device.

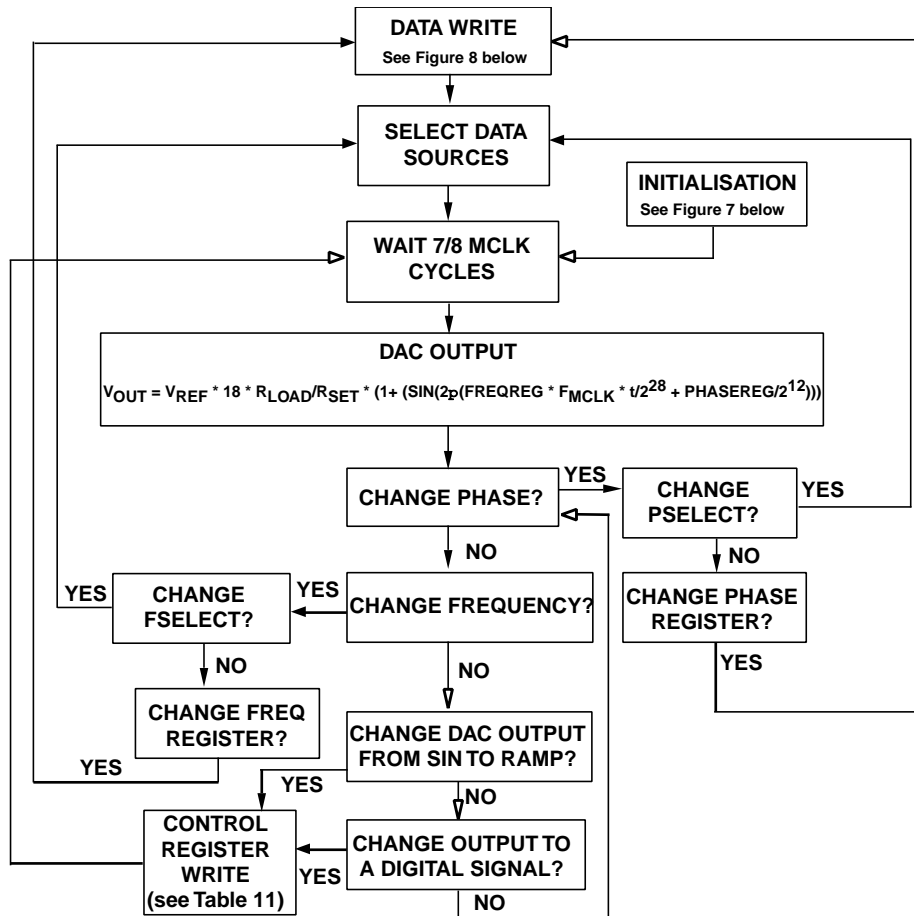

Figure 6. Flow Chart for AD9833 Initialisation and Operation

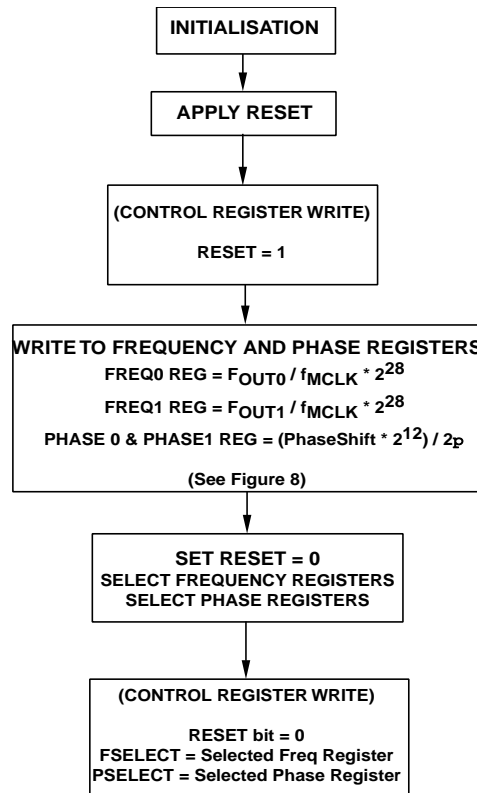

Figure 7. Initialisation

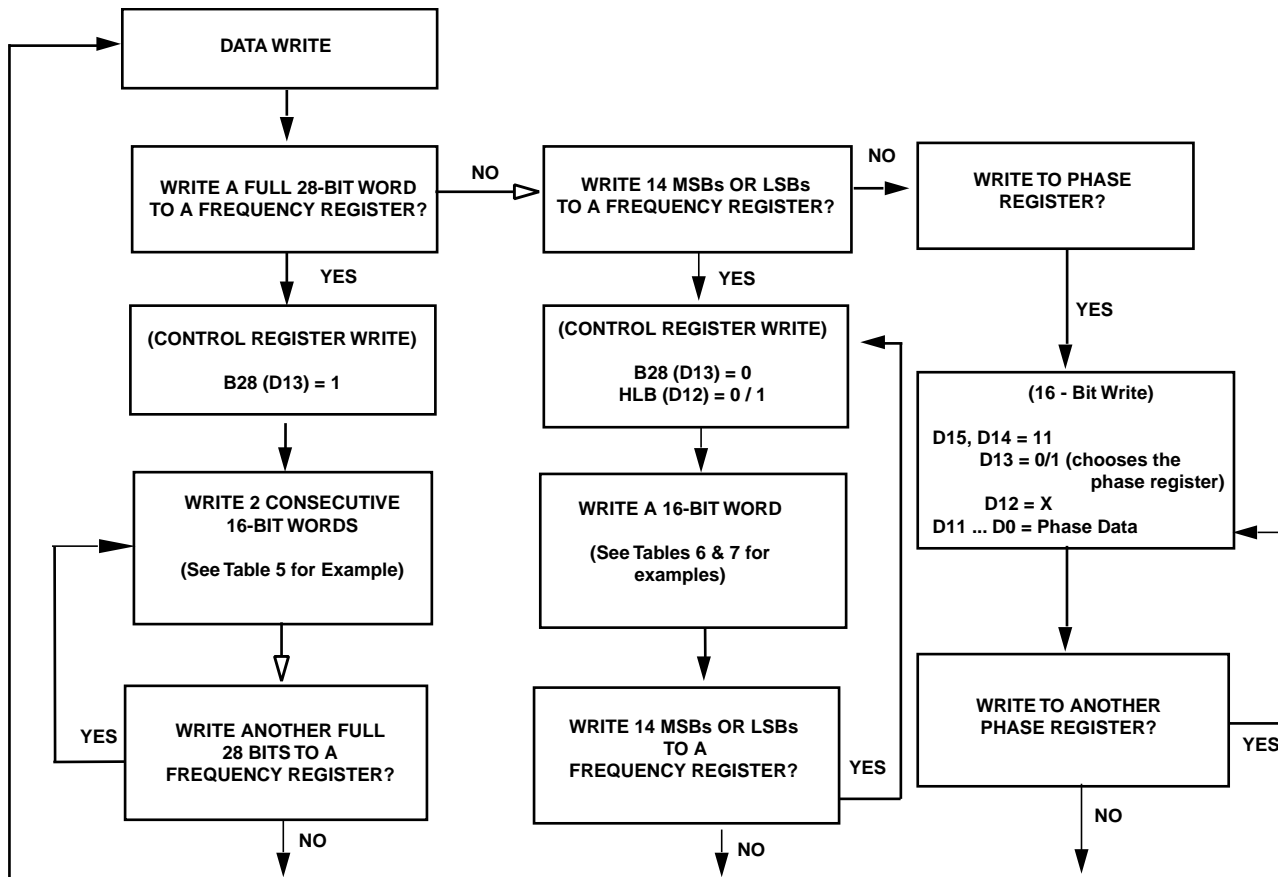

Figure 8. Data Writes

INTERFACING TO MICROPROCESSORS

The AD9833 has a standard serial interface which allows the part to interface directly with several microprocessors. The device uses an external serial clock to write the data/control information into the device. The serial clock can have a frequency of 40 MHz maximum. The serial clock can be continuous or, it can idle high or low between write operations. When data/control information is being written to the AD9833, FSYNC is taken low and is held low while the 16 bits of data are being written into the AD9833. The FSYNC signal frames the 16 bits of information being loaded into the AD9833.

AD9833 to ADSP-21xx Interface

Figure 9 shows the serial interface between the AD9833 and the ADSP-21xx. The ADSP-21xx should be set up to operate in the SPORT Transmit Alternate Framing Mode (TFSW = 1). The ADSP-21xx is programmed through the SPORT control register and should be configured as follows:

- Internal clock operation (ISCLK = 1)
 - Active low framing (INVTFS = 1)
 - 16-bit word length (SLEN = 15)
 - Internal frame sync signal (ITFS = 1)
 - Generate a frame sync for each write (TFSR = 1).
- Transmission is initiated by writing a word to the Tx reg-

ister after the SPORT has been enabled. The data is clocked out on each rising edge of the serial clock and clocked into the AD9833 on the SCLK falling edge.

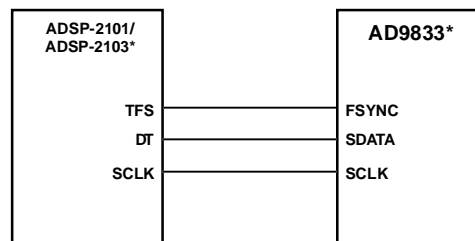

* ADDITIONAL PINS OMITTED FOR CLARITY

Figure 9. ADSP2101/ADSP2103 to AD9833 Interface

AD9833 to 68HC11/68L11 Interface

Figure 10 shows the serial interface between the AD9833 and the 68HC11/68L11 microcontroller. The microcontroller is configured as the master by setting bit MSTR in the SPCR to 1 and, this provides a serial clock on SCK while the MOSI output drives the serial data line SDATA. Since the microcontroller does not have a dedicated frame sync pin, the FSYNC signal is derived from a port line (PC7). The set up conditions for correct operation of the interface are as follows:

AD9833

SCK idles high between write operations (CPOL = 0) data is valid on the SCK falling edge (CPHA = 1). When data is being transmitted to the AD9833, the FSYNC line is taken low (PC7). Serial data from the 68HC11/68L11 is transmitted in 8-bit bytes with only 8 falling clock edges occurring in the transmit cycle. Data is transmitted MSB first. In order to load data into the AD9833, PC7 is held low after the first 8 bits are transferred and a second serial write operation is performed to the AD9833. Only after the second 8 bits have been transferred should FSYNC be taken high again.

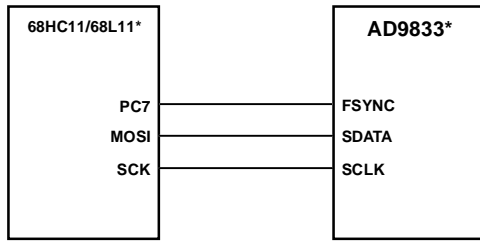

* ADDITIONAL PINS OMITTED FOR CLARITY

Figure 10. 68HC11/68L11 to AD9833 Interface

AD9833 to 80C51/80L51 Interface

Figure 11 shows the serial interface between the AD9833 and the 80C51/80L51 microcontroller. The microcontroller is operated in mode 0 so that TXD of the 80C51/80L51 drives SCLK of the AD9833 while RXD drives the serial data line SDATA. The FSYNC signal is again derived from a bit programmable pin on the port (P3.3 being used in the diagram). When data is to be transmitted to the AD9833, P3.3 is taken low. The 80C51/80L51 transmits data in 8 bit bytes thus, only 8 falling SCLK edges occur in each cycle. To load the remaining 8 bits to the AD9833, P3.3 is held low after the first 8 bits have been transmitted and a second write operation is initiated to transmit the second byte of data. P3.3 is taken high following the completion of the second write operation. SCLK should idle high between the two write operations. The 80C51/80L51 outputs the serial data in a format which has the LSB first. The AD9833 accepts the MSB first (the 4 MSBs being the control information, the next 4 bits being the address while the 8 LSBs contain the data when writing to a destination register). Therefore, the transmit routine of the 80C51/80L51 must take this into account and re-arrange the bits so that the MSB is output first.

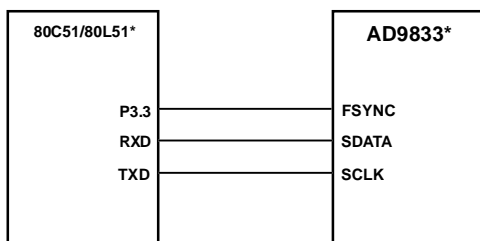

* ADDITIONAL PINS OMITTED FOR CLARITY

Figure 11. 80C51/80L51 to AD9833 Interface

AD9833 to DSP56002 Interface

Figure 12 shows the interface between the AD9833 and the DSP56002. The DSP56002 is configured for normal mode asynchronous operation with a Gated internal clock (SYN = 0, GCK = 1, SCKD = 1). The frame sync pin is generated internally (SC2 = 1), the transfers are 16 bits wide (WL1 = 1, WL0 = 0) and the frame sync signal will frame the 16 bits (FSL = 0). The frame sync signal is available on pin SC2 but, it needs to be inverted before being applied to the AD9833. The interface to the DSP56000/DSP56001 is similar to that of the DSP56002.

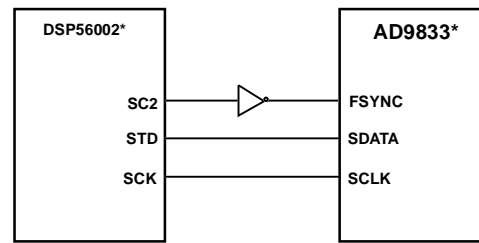

* ADDITIONAL PINS OMITTED FOR CLARITY

Figure 12. AD9833 to DSP56002 Interface

AD9833 EVALUATION BOARD

The AD9833 Evaluation Board allows designers to evaluate the high performance AD9833 DDS modulator with minimum of effort.

To prove that this device will meet the user's waveform synthesis requirements, the user only require's a power-supply, an IBM-compatible PC and a spectrum analyser along with the evaluation board.

The DDS evaluation kit includes a populated, tested AD9833 printed circuit board. The evaluation board interfaces to the parallel port of an IBM compatible PC. Software is available with the evaluation board which allows the user to easily program the AD9833. A schematic of the Evaluation board is shown in Figure 13. The software will run on any IBM compatible PC which has Microsoft Windows95, Windows98 or Windows ME 2000 NT™ installed.

Using the AD9833 Evaluation Board

The AD9833 Evaluation kit is a test system designed to simplify the evaluation of the AD9833. An application note is also available with the evaluation board and gives full information on operating the evaluation board.

Prototyping Area

An area is available on the evaluation board for the user to add additional circuits to the evaluation test set. Users may want to build custom analog filters for the output or add buffers and operational amplifiers to be used in the

final application.

XO vs. External Clock

The AD9833 can operate with master clocks up to 25 MHz. A 25 MHz oscillator is included on the evaluation board. However, this oscillator can be removed and, if required, an external CMOS clock connected to the part.

Power Supply

Power to the AD9833 Evaluation Board must be provided externally through pin connections. The power leads should be twisted to reduce ground loops.

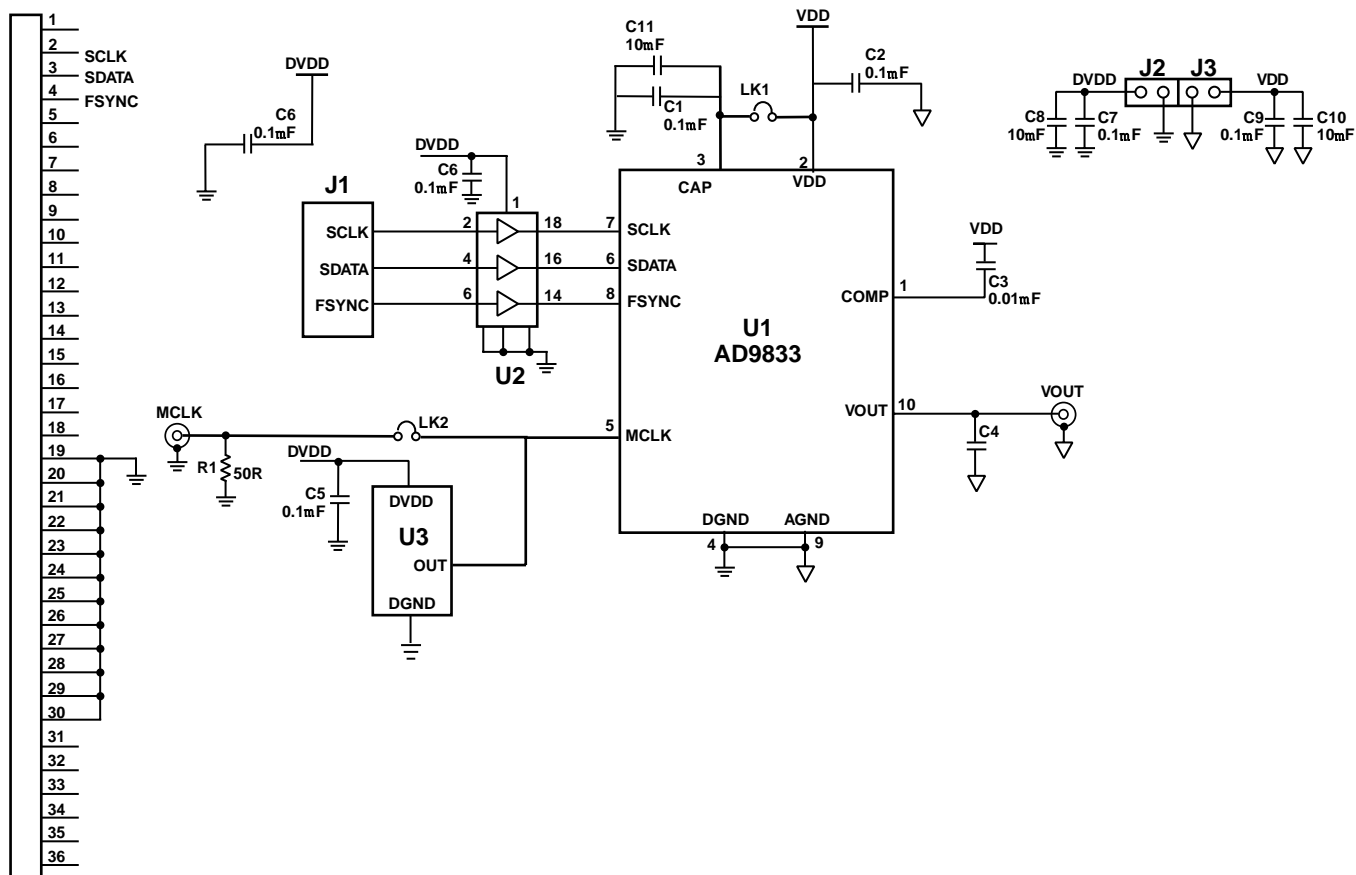

Figure 13. AD9833 Evaluation Board Layout

Integrated Circuits

- U1 AD9833BRU
- U2 74HCT244
- U3 OSC XTAL 25 MHz

Links

- Lk1 Lk2 2 pin sil header

Sockets

- MCLK VOUT Sub Miniature BNC Connector

Capacitors

- C1 C2 100nF Ceramic Capacitor 0805
- C5 C6 C7 C9 100nF Ceramic Capacitor
- C3 10nF ceramic Capacitor
- C8 C10 C11 10uF Tantalum Capacitor
- C4 Option for extra decoupling capacitor

Connectors

- J1 36-Pin Edge Connector
- J2, J3 PCB Mounting Terminal Block

Resistor

- R1 51 Ω Resistor

AD9833

OUTLINE DIMENSIONS
 Dimensions shown in inches and (mm).

**10-Lead mSOIC Package
 (RM-10)**

